

OCTAVE

Jubilee Preamp

Owner's Manual

English

FOREWORD

I wish to personally thank you for choosing OCTAVE products and congratulate you on your purchase of your new

Jubilee Preamplifier

Here at our head office in Karlsbad, right on the edge of the Black Forest, we have been designing and building high quality, long-lasting hi-fi equipment for over 35 years that will – quite literally – provide you with hours of musical pleasure for many years to come.

Today's loudspeakers and high-resolution source equipment continue to be very demanding of amplifiers. As a result, achieving improved amplifier sound quality requires greater levels of technical innovation than ever before.

OCTAVE specializes in the ongoing development of upgradeable circuit designs and has earned a reputation over recent years as a world leader in the field of high-end tube amplifier design. Thanks to our years of experience and our in-depth understanding of amplifier technologies and their side effects, OCTAVE is able to achieve a musical quality and degree of reliability that seemed impossible or unaffordable only a few years ago.

I trust that you will enjoy many hours of wonderful music with your OCTAVE Amplifier.



Andreas Hofmann
Chief Designer and Owner of OCTAVE Audio

CONTENTS

	Page
Foreword	
1. Introduction	
1.1. What makes OCTAVE amplifiers special?	4
1.2. Description of the Jubilee preamplifier	5
2. Safety precautions	
2.1. Before you begin	6
2.2. Placement	7
2.3. Warranty	7
3. Getting started	
3.1. Unpack and check the content	8
3.2. Connecting the amplifier	8
3.3. Running in	9
4. Operation	
4.1. Jubilee preamplifier front panel	10
4.2. Jubilee preamplifier top view	11
5. Connections	
5.1. Rear panel Jubilee preamplifier	12
5.2. Rear panel Jubilee power supply	14
6. Remote Control for volume	
6.1. Remote control transmitter	15
6.2. Remote control receiver	16
7. Tubes	
7.1. Tube layout	17
7.2. General information	18
7.3. Replacing tubes	18
8. Options	
8.1. Stepped Attenuator for volume	19
8.2. HT Bypass	19
9. Troubleshooting	20
10. Specification	
10.1. Technical data	22
10.2. Dimensions	23
10.3. Diagrams	25

1. INTRODUCTION

1.1. WHAT MAKES OCTAVE AMPLIFIERS SPECIAL?

- Sound**

The design goal of OCTAVE amplifiers is honest, natural sound reproduction. The sound characteristics of an amplifier are derived from the sum of all its parts. Tubes themselves do not only guarantee high quality sound. This means that a high degree of technical skill must be applied to optimizing every detail in order to design a reliable amplifier that will maintain its characteristics over time and that will convince the critical listener over the long term that its reproduction of music is both honest and natural
- Amplifier design**

The frequency range and output resistance limitations of classic tube designs are evident as soon as you connect the amplifiers. These designs often only perform to their full potential when they are used with special power Amplifiers. OCTAVE amplification and power supply technology has largely overcome these well-known problems. Thanks to their unique output stage design, they will maintain their optimum sound quality with virtually any amplifier.
- Control + monitoring**

OCTAVE employs the latest electronic circuit designs to create the best possible operating conditions for the tubes, and thus for the amplifier itself.

OCTAVE tube technology

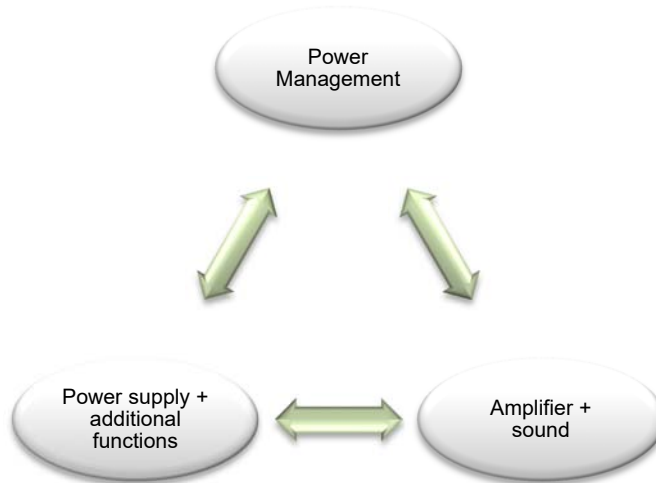

OCTAVE amplifiers are equipped with a proprietary control and monitoring system we call **Power Management**. This is an “electronic brain” within the amp that regulates and controls all of the amplifier's functions. It includes soft start electronics that gently increase the heater and supply voltage to minimize component wear. In the event of a problem, the Power Management’s **protection system** disconnects the unit from the power supply. Power Management helps us to achieve a completely consistent sound while at the same time ensuring the total reliability of our products.

- Hand built**

OCTAVE amplifiers are hand built and individually 100% tested. They are designed and developed by Andreas Hofmann. The company has its own winding department, in which all transformers are especially custom-wound for each amplifier.
- Made in Germany**

OCTAVE amplifiers are 100% built in Germany. Our employees are highly qualified and committed. We work closely with local mechanical suppliers. The hardware components are all manufactured on modern CNC machines. We use only the best, most durable electronic components. We can repair all Octave amplifiers, no matter how old they are.

1. INTRODUCTION

1.2 DESCRIPTION OF THE JUBILEE PREAMPLIFIER

Circuit design

OCTAVE has designed its reference amplifier – the Jubilee preamp – as a *two-stage hybrid amplifier*. Tube circuitry manages the high precision *balanced stage* and amplifies the signal. The *high output current* requirements are satisfied by an output impedance converter implemented with semiconductors. The unique combination of tubes and transistors allows the Jubilee to do without overall negative feedback and thus deliver the undeniable sonic benefits of a *zero feedback design*. However, any amplifier that dispenses with negative feedback also dispenses with the corrective mechanism provided by negative feedback circuitry. In the Jubilee preamplifier, we solve this problem through the extremely high specification of the output stages and power supply section, creating virtually perfect conditions for achieving *perfectly accurate amplification* – without the need for corrective mechanisms.

Whether the source equipment is connected via the RCA / CINCH phono or XLR inputs, the Jubilee tube preamp always produces a *perfectly balanced output signal* and delivers an optimum sonic performance independent of the source type. The XLR inputs are fitted with step-up transformers that have no sonic signature of their own. Because they introduce no noise or phase shifts, step-up transformers are the technology of choice for this application in professional recording studios. In addition, they also perform the function of a ground lift circuit, eliminating the risk of interference and hum, which is particularly critical when it comes to complex multi-amp combinations connected via balanced inputs.

The *low impedance output* is yet another feature designed to enhance the sound quality and versatility of the Jubilee preamplifier. Only a semiconductor-based output stage is able to cope with long cable runs and integrate perfectly with low impedance power amplifiers. It would be impossible to implement such an uncritical output using tubes alone without sacrificing accuracy in the low bass and extreme high frequencies.

Outboard power supply

The outboard power supply, which was developed exclusively for the Jubilee preamplifier, substantially enhances the sound quality of the preamp by separating the preamplifier from the mains (simulated battery operation). The *separate power supply* stops mains noise from entering the preamp's signal processing circuitry. It also provides highly accurate and stable electronic voltage regulation, which is one of the ways we ensure this product's consistent performance over time.

Power management system

The Jubilee's sophisticated power management system guarantees a long and reliable life and incorporates highly refined soft-start technologies that help the tubes achieve their theoretical maximum service life of up to 10,000 hours.

Build quality

The volume control with its precision ball bearings is centrally placed within a polished Labrador natural stone slab, flanked by two, three-centimeter thick, solid aluminum panels. The extremely stable, low resonance, all-aluminum casing eliminates any possibility of magnetic distortion. Before leaving the factory, each hand-built Jubilee preamplifier is thoroughly inspected and subjected to a 48-hour endurance test.

2. SAFETY INSTRUCTIONS

2.1. Before you begin

In case of emergency: disconnect the plug from the mains supply

Never use an amplifier that is damaged or faulty. Make sure it has been labeled as defective and that it cannot be used until it has been repaired by a qualified service engineer. Make sure that there is easy access to the IEC socket and power cable.



Do not open the case

There are dangerously high voltages and hot tubes inside this equipment. To avoid a burn or the risk of electric shock, never allow anyone except qualified personnel to open the case or remove the grill.

Service and maintenance

For reasons of safety, please ensure that servicing, repairs and other modifications to OCTAVE equipment are carried out only by a qualified technician. Defective fuses should also only be replaced by a qualified technician. Always replace fuses with ones of the same type and rating. If your amplifier requires servicing, please ship or take your equipment directly to OCTAVE or to one of our authorized service centers.

Symbols and terms used in this instructions

	<p>Caution! Text passages marked with this symbol contain important information which must be observed if the amplifier is to operate safely and without problems.</p>
	<p>This information symbol marks text passages which provide supplementary notes and background information; they are intended to help the user understand how to get the best out of the amplifier</p>

Before connecting

Make sure that the voltage of your amplifier matches your local mains voltage.

Grounding

This amplifier is a protection class 1 device, (except 100V versions for Japan) with an earth conductor. Therefore a three-pin power cable with a protective earth contact must be used (included in the scope of delivery).

2. SAFETY PRECAUTIONS

2.2. Placement

Location

- OCTAVE equipment is designed strictly for use in a dry domestic environment with a room temperature up to 25°C. Do not use it in open air or in damp environments!
- Never place plants or liquid-filled containers on your amplifier. Take care that objects do not fall or liquids are not spilled into the enclosure. Should this happen, disconnect the mains plug immediately and have your amplifier checked by a qualified service technician.
- Condensation may form if the amplifier is taken from a cold environment into a warm one. In this case, wait until the amplifier has reached room temperature and is dry before switching it on.
- Avoid installing the amplifier close to sources of heat, such as heaters, or anywhere that it may be in direct sunlight.
- Do not operate your OCTAVE amplifier near flammable materials, gases, or vapors. Avoid areas where there may be heavy accumulations of dust or where the amplifier may be subject to mechanical vibration.
- Place your OCTAVE amplifier on a stable, even surface.

Cover

Never operate the amplifier without the cover.

Ventilation

- Ensure sufficient air circulation around your amplifier. If you intend to install your equipment in a cupboard or a shelf unit, ensure that there is at least a 25 centimeter gap between the ventilation slots and the walls all around the amplifier.
- To prevent heat accumulation, the back of the cupboard should have ventilation holes.
- Do not rest the equipment on a soft surface such as carpet or foam sheeting.

2.3. Warranty

OCTAVE can only guarantee the safety, reliability and performance of this unit if modifications and repairs are carried out by specialized personnel and if the amplifier is operated in accordance with the instructions contained in this manual.

3. GETTING STARTED

3.1. Unpack and check the content

Scope of delivery	
-	Tube preamplifier Jubilee preamp
-	External power supply
-	Power cord
-	Remote control for volume
-	Octave cleaning cloth and soft gloves
-	Owner's manual with certificate

3.2. Connecting the amplifier

1. In your own interest, please observe the Safety Precautions in Section 2.1 and the Positioning advice in Section 2.2.
2. Before connecting your OCTAVE amplifier, switch off all other hi-fi equipment. This will avoid possible problems when you connect your other components to the preamp.
3. Connect your source components such as CD player, a phono preamplifier, a tuner and one or two recording devices. You will find advice on connecting your source components and information on pin connections in Section 4.1.
Connect the cables from your signal sources such as CD player to the appropriate inputs (XLR or RCA / CINCH phono) on your Jubilee preamplifier.

4. Connect the signal cables from your Jubilee preamplifier (XLR or RCA / CINCH) to the appropriate inputs on your power amplifiers.



Make sure that the power supply is switched off before you connect the power supply cable. When inserting the connector, observe the anti-rotation lug and take care not over tighten the coupling ring.

5. Turn the volume control anticlockwise close to the minimum setting. Remember that high sound pressure levels can damage to your hearing as well as your loudspeakers.
6. Connect the power supply to the wall socket. Plug the power cord [24] of the Jubilee power supply into the special socket on the preamplifier. [19]

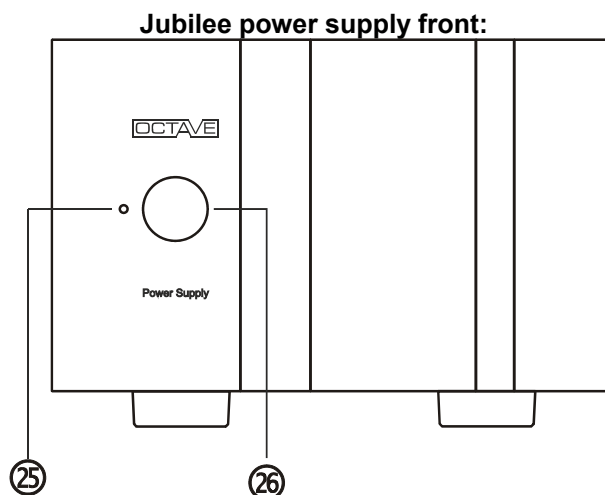

3. GETTING STARTED

7. Switch the power supply on (switch [26]. LED [25] on the front panel of the power supply will illuminate. Wait until the Muting LED [1] on the Jubilee preamplifier goes out. The unit will be ready for use in about four minutes.
8. Now you can adjust the settings (GAIN, PHASE etc.) as described in Section 3.
9. Switch your other components on.
10. Select a source using input selector knob [3] and adjust the volume to your normal listening level.
11. Running in: Tube equipment generally takes about three months to run in and start sounding its best. Daily use is useful during this period but it is not necessary to leave the equipment on continuously, as this does not greatly reduce the running-in time.
12. Please keep this manual safe for future reference and retain the original packing for use whenever your amplifier is transported.

3.3. Running in

All OCTAVE equipment is subject to a 48-hour endurance run to burn in the tubes. The tubes are pre-selected for use in each particular model.

The sound quality of tube equipment improves throughout the initial running-in period of up to three months.

4. OPERATION

4.1 JUBILEE PREAMPLIFIER FRONT PANEL

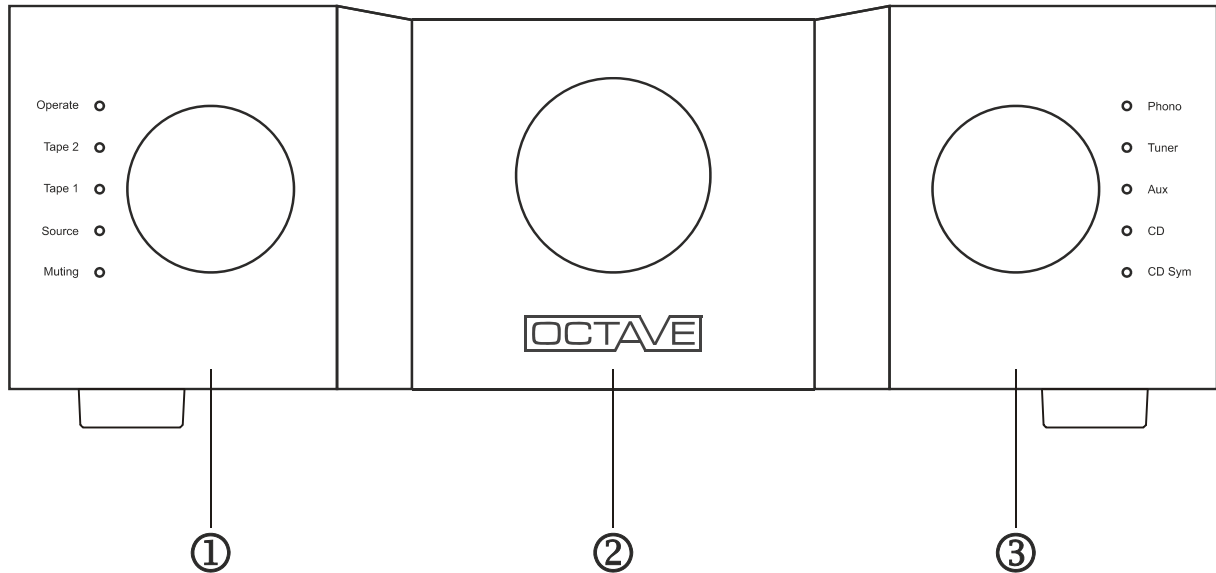

The Jubilee preamplifier is equipped with a delay timer function that helps conserve tube life. The output is muted (muting LED illuminates) for four minutes during the start phase. The muting function is also activated when the gain switch [4] is used (See Sec. 3.2.)

Legend	
①	<p>MODE SELECTOR KNOB</p> <p>Operate Is the outboard power supply switched on, the Operate LED illuminates the correct work of the power supply. This LED needs 2 minutes delay. When the Muting LED switches off, the amplifier is ready for use.</p> <p>Tape 2 Bypass Playback of recorder connected to the Tape 2 input</p> <p>Tape 1 Source Playback of recorder connected to the Tape 1 input</p> <p>Source Playback of the source that has been selected with the input selector knob [3]. If the Mode Selector is set to Source, you can record the source you are listening to via the two tape outs (Tape 1, Tape 2). To do this, Tape Copy [6] must be switched off (see Section 3.2).</p> <p>Muting You should mute the preamplifier outputs by <i>Connecting</i> turning the knob to the Muting position (LED illuminates) before connecting or disconnecting source equipment. The muting switch allows you to do this without having to switch the Jubilee preamplifier off.</p>
②	<p>VOLUME CONTROL</p> <p>Turn the volume control anticlockwise near to its zero position (close to 8 o'clock) before switching on. High sound pressure levels can damage your hearing as well as your loudspeakers.</p>
③	<p>INPUT SELECTOR KNOB (SOURCE)</p> <p>Selects the input sources Phono, Tuner, Aux, CD and CD Sym (balanced XLR input). See also Connections on page 10.</p>

4. OPERATION

4.2 JUBILEE PREAMPLIFIER TOP VIEW

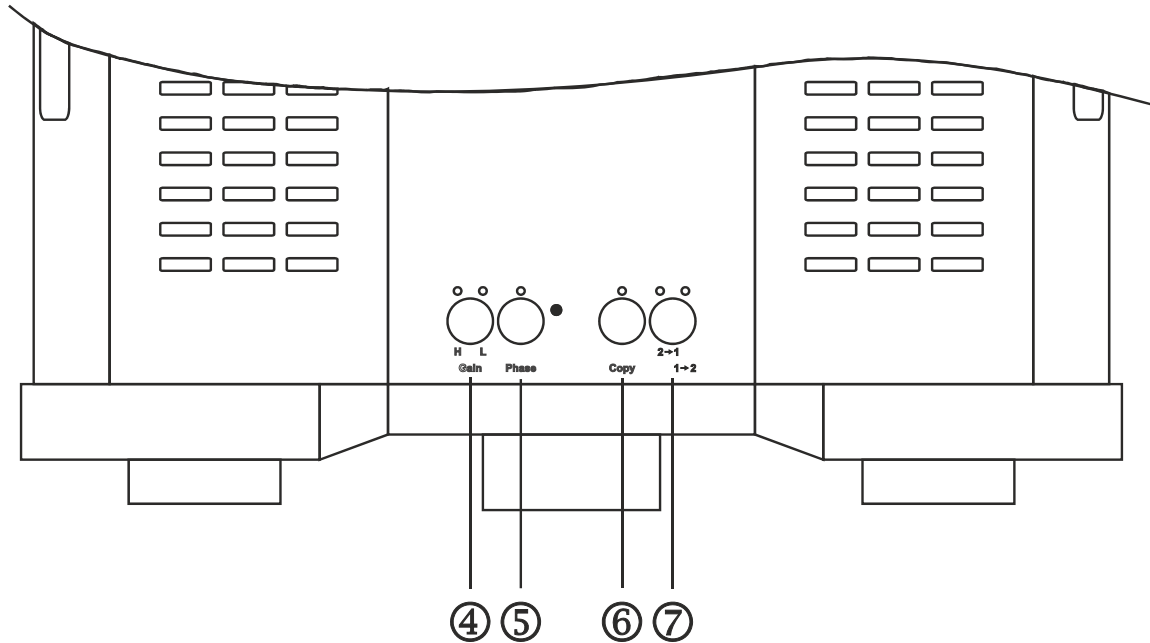

Legend

④	<p>GAIN Facility for switching between high (H) and low (L) gain. The appropriate LED illuminates to show which position is active.</p> <p>H (HIGH) position: This is the standard position for the majority of power amplifiers and loudspeakers.</p> <p>L (LOW) position: A lower gain setting is recommended only when high efficiency speakers such as horns are being used.</p> <p>When switching between gain settings, the muting function is activated to prevent switching noises being sent to your amplifier and loudspeakers. The outputs are restored after a short time. (The muting LED turns off.) The gain and phase switches should not be operated at the same time or immediately after each other, as this could cause cracking noises through your system.</p>
⑤	<p>PHASE SWITCH Phase switching of the output signal (0 and 180 degrees) applies to both the balanced XLR and the RCA / CINCH phono outputs.</p> <p>LED on: 180 degrees phase shift LED off: 0 degrees phase shift</p>
⑥	<p>COPY (tape copy function, tape to tape) LED on: Tape Copy on LED off: Tape Copy off</p> <p>Copying can be carried out from Tape 1 to Tape 2 and vice versa. Select the copy direction with pushbutton switch [7] (2->1 or 1->2).</p>
⑦	<p>Tape Copy direction</p> <p>2 → 1 (LED illuminated) Tape 2 is the source; Tape 1 is recording 1 → 2 (LED illuminated) Tape 1 is the source; Tape 2 is recording</p> <p>You can monitor your recordings with the mode selector knob [1] in positions Tape1 or Tape2</p>

5. CONNECTIONS

5.1 REAR PANEL JUBILEE PREAMPLIFIER

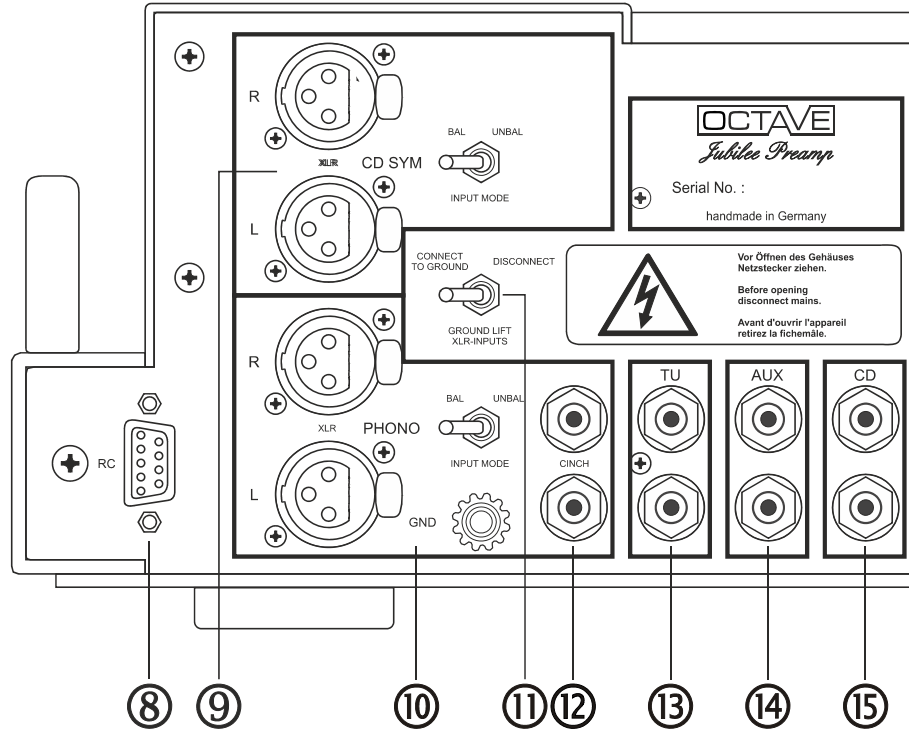

General points: The following applies to all connections: L: LEFT channel, R: RIGHT channel
 XLR pin : 1: GROUND, 2: + 3: -

Legend

- ⑧ **RC:** Connector for the infrared receiver. The remote control is standard
- ⑨ **CD SYM Section:** Line level XLR input for sources with balanced outputs (CD player)
 The **INPUT MODE switch** CD SYM allows to switch the CD XLR input between balanced (XLR) and unbalanced mode.
- ⑩ **PHONO Section:** An additional line level input with the option of XLR or RCA / CINCH inputs that you can use to connect sources such as an external balanced phono preamplifier.
 The **INPUT MODE switch** allows to switch from balanced (XLR) to unbalanced (RCA / CINCH) mode. Both of these inputs are wired in parallel. Please note that only one line level phono input (either XLR or RCA / CINCH) can be used at a time. The PHONO inputs are not suitable for use with a turntable without an external phono preamplifier.
GND (GROUND)
 Additional ground connection for external units like phono preamp and so on
- ⑪ **GROUND LIFT XLR-INPUTS:** Ground lift switch for XLR inputs
Switch position: CONNECT TO GROUND:
 Connects the XLR ground to chassis ground (see 7.1 Troubleshooting: hum on XLR input)
Switch position: DISCONNECT
 Disconnects the XLR input ground from the output ground
 In true balanced operation, the ground connection is not necessary, since it does not carry a signal. Lifting the ground will help keep out unwanted noise and interference in balanced operation. If you have source equipment fitted with a separate earth, you can also use the DISCONNECT position to avoid ground loop problems. (Power amplifiers are also normally grounded.)
 If the INPUT MODE switch is in the ASYM position, XLR inputs are connected by default; GROUND LIFT does not work for this input

5. CONNECTIONS

5.1 REAR PANEL JUBILEE PREAMPLIFIER

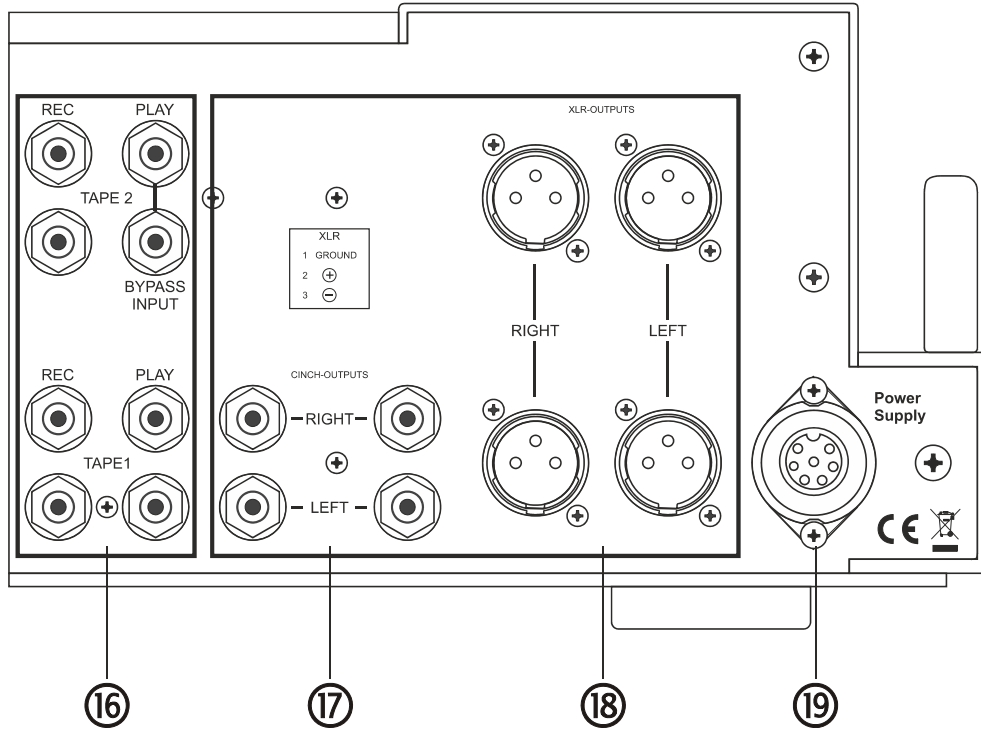

Legend

12	Phono preamp inputs (RCA/CINCH) These inputs are active in the PHONO INPUT MODE ASYM setting. The RCA / CINCH inputs are wired in parallel to the balanced (XLR) inputs. You can use either the RCA / CINCH or the XLR sockets to connect a phono preamp.
13	Tuner input (RCA / CINCH) Additional line level input for a tuner
14	AUX input (RCA / CINCH) Additional line level input for other sources.
15	CD input (unbalanced RCA / CINCH) Additional input for CD player
16	Tape inputs/outputs Analogue inputs/outputs for two recording devices (DAT, CD etc) Tape 2 REC Output (record) Tape 2 Tape 2 PLAY Input (playback) Tape 2. With option BYPASS tape 2 play is the bypass input. Gain from bypass to RCA out is 0 dB for gain low and + 6 dB for the balanced outputs. Tape 1 REC Output (record) Tape 1 Tape 1 PLAY Input (playback) Tape 1
17	RCA / CINCH outputs
18	XLR outputs
19	Power Supply Connection for the external power supply.

5. CONNECTIONS

5.2 REAR PANEL JUBILEE POWER SUPPLY

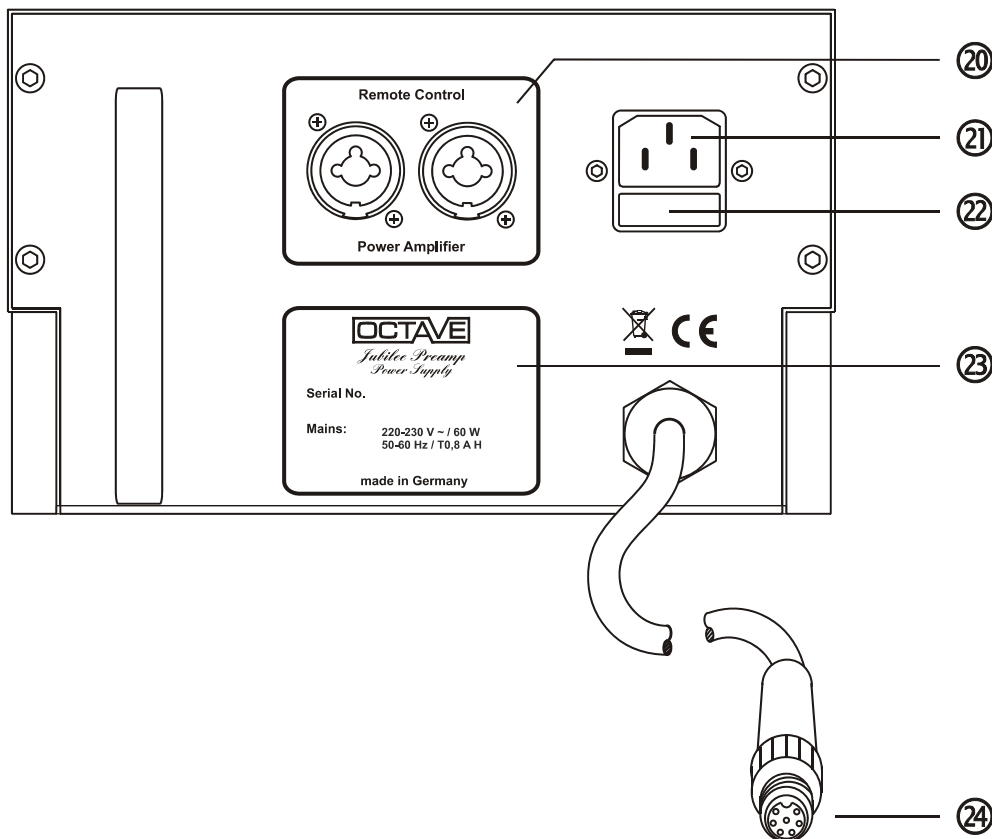

Legend	
⑳	Remote control for the Jubilee power amplifiers Remote switching of the mains power of the Jubilee amps. Connector: 6,3 mm jack plug (mono)
㉑	Mains Power connection Before connecting the mains power cord into the wall socket, make sure that your amplifier is suitable for your local supply voltage. To exclude the risk of electric malfunction, connect the power supply with the Jubilee preamp <u>before</u> you connect the power supply to the mains.
㉒	Fuse holder Warning: Fuses should be changed only by a qualified technician. 5 x 20 mm IEC standard; Slow blow, type H: 220-230 V : 0.8 A H 110-115 V: 1.6 A H 100 V: 1.6 A H A Fuses must be replaced with ones of the same type and rating (refer to markings on original fuse)
㉓	Serial number and mains
㉔	Connecting cable from the power supply to the Jubilee preamplifier Please switch off the power supply before connecting this cable to the preamp. Observe the anti-rotation lug and take care not over tighten the coupling ring.

6. REMOTE CONTROL FOR VOLUME

6.1. REMOTE CONTROL TRANSMITTER

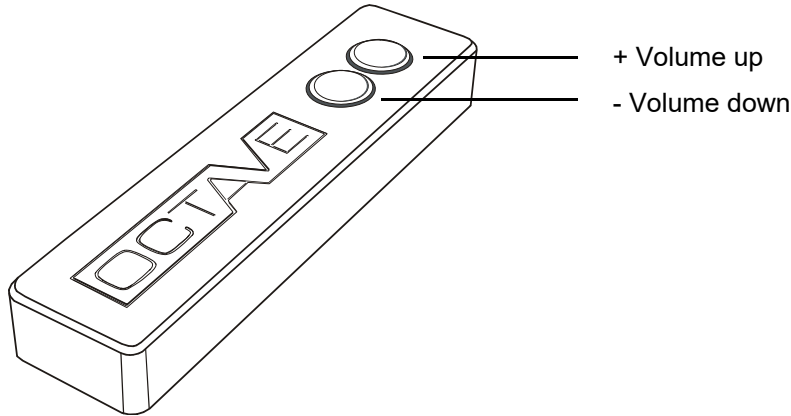

Changing the batteries

Procedure	
1	Take off the bottom plate (three screws size Phillips 1)
2	Change the batteries: 2 x Type AAA 1.5 V alkali-manganese / alkaline) <u>Please take care not to push the buttons of the remote control while inserting the new batteries.</u> If it still happens that the remote control does not work after changing the batteries, remove the new batteries and wait for the minimum of <u>30 minutes</u> . After half an hour you can insert the new batteries again and the remote control should work.
3	Mount the bottom plate again, tighten the screws not too hard.
	Please don't trash the old batteries. Batteries must be disposed of as special waste. Stores that sell batteries should provide containers for the collection of used batteries

Specification	
Weight	0,256 kg
Dimensions	15.6 x 3.5 x 2.3 cm (L x W x H)



You cannot control the volume with the remote control in case of the option stepped attenuator

6. REMOTE CONTROL FOR VOLUME

6.2. REMOTE CONTROL RECEIVER

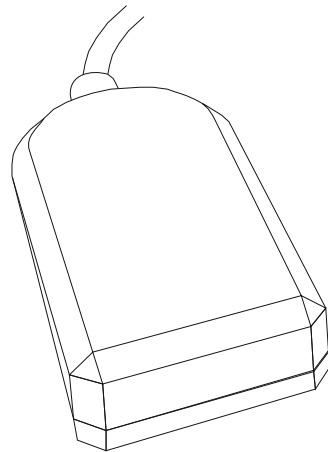

Remote Control
Receiver

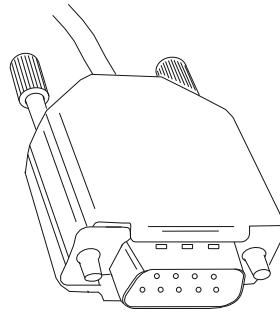

Connector to
the rear panel

Because it would not be very aesthetic to drill a hole in the Jubilee front panel, we decided to use a solution with an external receiver

Procedure

- 1 Connect the receiver with the plug on the rear panel
- 2 Put the receiver wherever you want The receiver must be in optical reachability

Specification

Weight	0.08 kg
Dimensions	5.5 x 3.2 x 2.0 cm (L x W x H)
Cable length:	110 cm

7. TUBES

7.1 TUBE LAYOUT

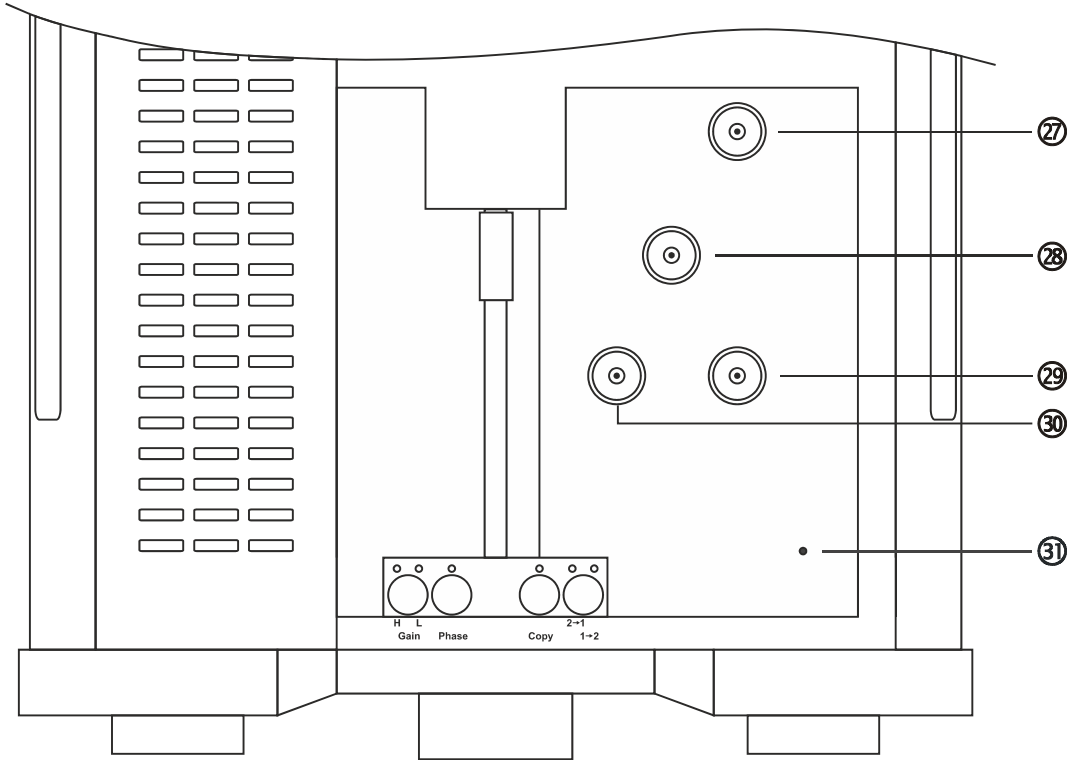

Tube replacement should be done by a technician. Before opening the cover it is mandatory to remove the power cord from the mains power inlet.

	Tubes used	also available under this description
②⑦, ②⑧, ②⑨, ③①	ECC 82	(E82CC, ECC802S, 12AU7, 5814, 6189W)
	Sockets [29] and [30] require selected, matched tubes with equal systems. The systems of tube [27] + [28] must be matched to less than 5% In position [27] the use of the genuine special tube E80CC is allowed. The use of this tube is only in this position practical!	
③①	Automatic discharge LED (red) LED on: When the amplifier has been switched off, this LED remains lit until the power supply capacitors have been discharged. LED off The power supply capacitors are discharged. If disconnected from the mains supply, there are no dangerous voltages present inside the equipment	

7. TUBES

7.2 GENERAL INFORMATION

Tube life

Thanks to the protection circuits and soft-start electronics, you can expect your output tubes to last for an average of five years.

Differences in tube service life

Faulty tubes can be replaced individually. It is not necessary to replace an entire set.

Running in

New tubes can require a relatively long time (up to 300 hours) to achieve their optimum sound quality.

Faulty tubes

Manufacturing faults in tubes may only become evident after about 100 hours of use. You should therefore be wary of installing untested tubes. However, faulty tubes or tubes of the incorrect type will normally not damage the amplifier. Nevertheless, they may cause loud crackling noises in your loudspeakers

7.3 REPLACING TUBES

Procedure	
1	For safety reasons, only qualified personnel should open the amplifier and replace the tubes
2	 Switch off the preamplifier, unplug the power cord from the wall socket and allow the unit 10 minutes to cool down
3	The Jubilee's automatic discharge system will discharge the power supply capacitors. The red LED [31] will be lit during this time (see Tube Layout, Section 6.1). To avoid an electric shock, wait until this LED has extinguished before opening the case.
4	Remove the acrylic cover and the right stainless steel lid above the input selector knob [3]. Remove the black aluminum plate above the tube board.
5	Take out the old tubes Carefully remove the tubes from their sockets, taking care not to exert sideward pressure on the sockets
6	Fit new tubes Please only use original OCTAVE replacement tubes. These have been tested and selected for use in our amplifiers. Please ensure that the tube pins are all perfectly straight before inserting your new tubes. Straighten any bent pins very carefully by hand if necessary. No adjustments are necessary to your amplifier after fitting new tubes.



Cleaning tips

Cleaning agents and contact cleaners are not recommended for tube sockets. Clean dirty sockets with compressed air and clean dirty tube pins carefully using a wire brush. A toothbrush dipped in isopropyl alcohol also works well.

8. OPTIONS

8.1 OPTION STEPPED ATTENUATOR FOR VOLUME

The volume control is an important component of a preamplifier. The demands placed on the controls are very high. The control range must encompass at least the range of 1:3000 (or 1:0.00033) to ensure fine adjustment appropriate for human hearing.

At the same time, the channel deviation within this range must not exceed 1 dB. The transfer resistance should remain constant during and after adjustment to prevent control noises. Rotary controls with a resistance track sensed by a slide meet these requirements to a large extent with our strict selection, but spring-guided sensing of the resistance track can result in undesired resonance effects that negatively affect the transfer resistance and impair the signal in the micro range. As a result of this design, the frequency bandwidth, i.e. the speed, may also be limited, depending on the control setting.

The control concept can only be improved with a stepped attenuator. In this complex process, the resistance track is reproduced by a series circuit consisting of individual resistors. The stepped attenuator now senses the connecting points of the resistor ladder.

The advantages of this solution are obvious: thanks to the low-tolerance fixed resistors, the channel tolerance across the entire control range remains under 0.1 dB. The hard gold plated contacts on the switch have an extremely low transfer resistance and thus do not generate micro-fluctuations in the signal level caused by mechanical resonances.

The switch has 47 settings. This uncommonly high number of settings allows for finely incremented, reproducible volume adjustment.

Equipped with this unique switching layout, the OCTAVE stepped attenuator functions as an ideal control. The sound characteristics are constant across the entire control range, while the center position also remains stable across the entire range thanks to the negligible channel tolerance. The sound pattern gains depth and the finest subtleties are audible in the layers of sound

However, as a result of the mechanical design of the stepped attenuator, the switch positions cannot be controlled using the remote control



8.2 OPTION HT BYPASS

A Bypass of the volume control is normally needed in case of using the preamp in a Home Theatre combination. Usually the volume is set at the Home Theatre Master Unit. We can add the Home Theatre Bypass on request.

The HT Input is than the TAPE 2 Play RCA Input. Gain of the Jubilee in HT setting is 0db. The function and the input is activated in the position TAPE 2 of the mode selector. A regular connection of a Tape is not possible with the Bypass Function installed.

9. TROUBLESHOOTING

Amplifier will not switch on

POSSIBLE CAUSES	The Jubilee power supply power cord is loose or not connected correctly
REMEDY	Connect power cord and check the wall socket and power connections
POSSIBLE CAUSES	No or faulty power connection between preamp and power supply
REMEDY	Check the connection of the power cord to the wall socket and the power cord between the Jubilee power supply and preamp
POSSIBLE CAUSES	Blown fuse in the Jubilee power supply
REMEDY	Have a qualified service engineer check your equipment and replace the fuses (identical rating and type!)

Preamp turns on, but no sound

POSSIBLE CAUSES	Amplifier has only recently been switched on or the gain switch has been operated
REMEDY	Wait until the preamplifier has warmed up (about. 4 minutes) and the Operate LED is lit
POSSIBLE CAUSES	The Jubilee preamplifier has muted (Muting LED illuminated) or the volume control is turned down
REMEDY	Deactivate Muting on the Mode Selector knob [1] (LED will extinguish) or slowly turn up the volume with volume knob [2] .
POSSIBLE CAUSES	Input selector knob or mode selector knob not set correctly
REMEDY	Check the setting of the Input Selector [3] and Mode Selector knob [1] .
POSSIBLE CAUSES	Power amplifiers or source equipment not switched on or not in play mode
REMEDY	Switch on power amplifiers. Switch on source equipment and play some music
POSSIBLE CAUSES	Problem with the installation: faulty cables between source equipment and/or power amplifier and the Jubilee preamplifier
REMEDY	Check cables and connections and correct faults

Humming and crackling

POSSIBLE CAUSES	The connecting phono plugs are not making a proper connection to ground
REMEDY	Check your interconnect cables and make sure that phono plugs are a tight fit. If the plugs appear loose, you can try bending the ground contacts (on the outside of the plug) in slightly.
POSSIBLE CAUSES	Inadequate contact between the phono plug's signal pin and the phono socket
REMEDY	Try another interconnect or, if necessary, have the RCA / CINCH phono sockets replaced by the OCTAVE service department.
POSSIBLE CAUSES	Hum on XLR input
REMEDY	GROUND LIFT XLR INPUTS [11] (See Connections in Sect. 4.1) in DISCONNECT position. Lifting the ground helps to prevent unwanted noise in balanced operation.

9. TROUBLESHOOTING

Cracking noises when switching on and off

POSSIBLE CAUSES	Household electrical equipment such as older refrigerators or 12-volt halogen lighting systems can generate strong radio interference when they switch on and off. This electrical interference can cause an audible crack or pop through the speakers.
REMEDY	Connect your hi-fi system to a central mains distribution board plugged into a wall socket. Do not connect any other electrical equipment either to the board or socket

Volume imbalance between the left and right channels

POSSIBLE CAUSES	Damaged cables and poorly fitting phono plugs can create resistance in the signal path, which can cause one channel to sound louder than the other. Recording equipment (reel-to-reel, cassette, CD or DAT recorder) with a faulty input or lead can overload the Record output and cause an imbalance between the left and right channels.
REMEDY	Change the lead, clean plugs and sockets with isopropyl alcohol. Warning: Do not use contact cleaning sprays. To isolate the cause of the problem, disconnect your recording device(s) one at a time. Check the interconnect cables used for recording and renew them if necessary. If you still have not alleviated the cause of the problem, have your recording equipment checked for faults.

Increased hiss on one channel

POSSIBLE CAUSES	Hiss that varies in level is a sign of a faulty or worn driver tube
REMEDY	You must replace the tube that is causing the problem. Return the amplifier to us if necessary. We will also gladly ship replacement tubes. You will find important instructions on replacing tubes in Section 6.1.

10. SPECIFICATION

10.1. TECHNICAL DATA

In- and Outputs	
Inputs	6 x RCA, 2 x XLR Home Theatre Bypass function on request (only RCA)
Outputs	2 x RCA, 2 x XLR, 2 x Tape Record (RCA)
Specification	
Frequency response (RCA / CINCH)	3 Hz – 100 kHz 1.5 dB
Total harmonic distortion	< 0.1% @ 3 V / 7.5 kOhm
Signal-to-noise ratio (weighted)	90 dB (Gain High) / 98 dB (Gain Low)
Maximum output voltage	8 V
Gain low/high RCA / CINCH	10 dB / 17,5 dB
Gain low/high XLR	16 dB / 23,5 dB
Channel separation	65 dB 1 kHz
Crosstalk rejection between inputs	86 dB 10 kHz
Crosstalk rejection, tape play/record	98 dB 10 kHz
Input impedance RCA / CINCH	100 kOhm
Input impedance XLR	2 kOhm
Output impedance	33 Ohms (RCA / CINCH) 2 x 33 Ohms balanced
Channel tracking of volume control	0.5 dB (-70 dB)
General data	
Power consumption	60 W
Input resistance RCA / CINCH	50 kOhm
Fuses	5 x 20 mm IEC standard Slow blow, type H 240 V: T 0.8 A H 220-230 V: T 0.8 A H 110-120 V: T 1.6 A H 100 V: T 1.6 A H
Weight, preamplifier / power supply	17.2 kg / 11.5 kg
Dimensions preamplifier	43.5 x 15.2 x 48.0 cm (W x H x D)
Dimensions power supply	22.0 x 15.2 x 48.0 cm (W x H x D)
Supplied accessories	Power cable, remote control

10. SPECIFICATION

10.2 DIMENSIONS

Dimensions Power Supply in mm

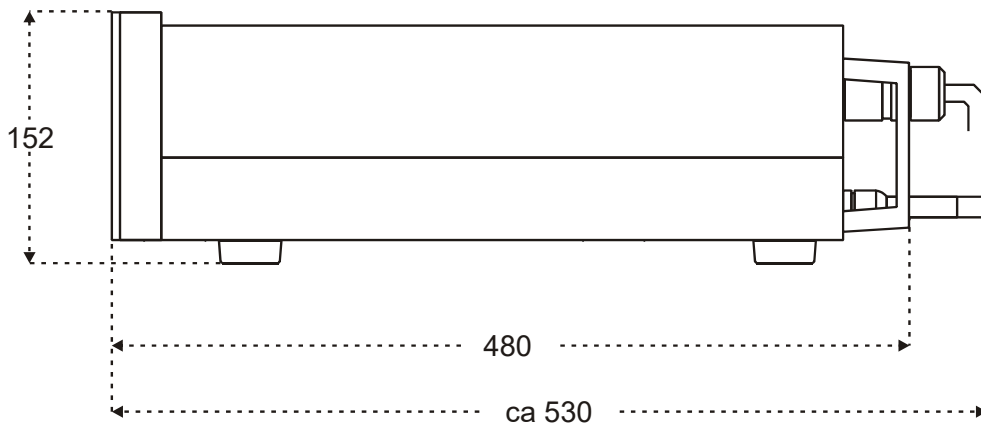
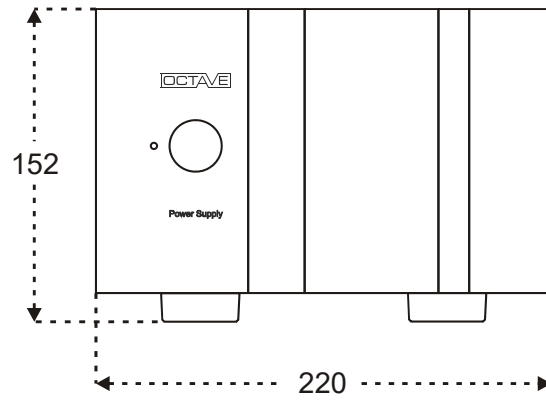

10. SPECIFICATION

10.2 DIMENSIONS

Dimensions Jubilee Preamp in mm

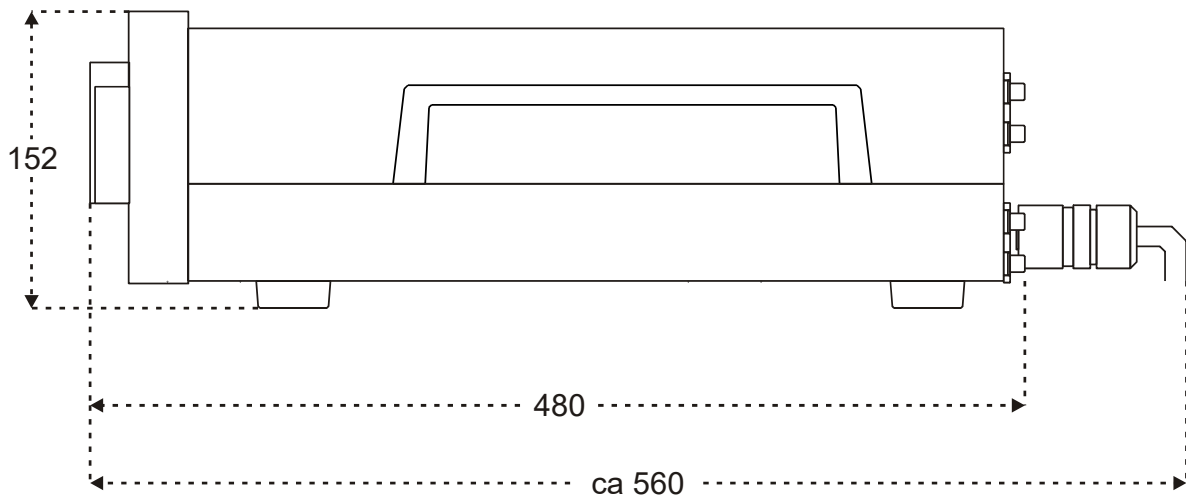
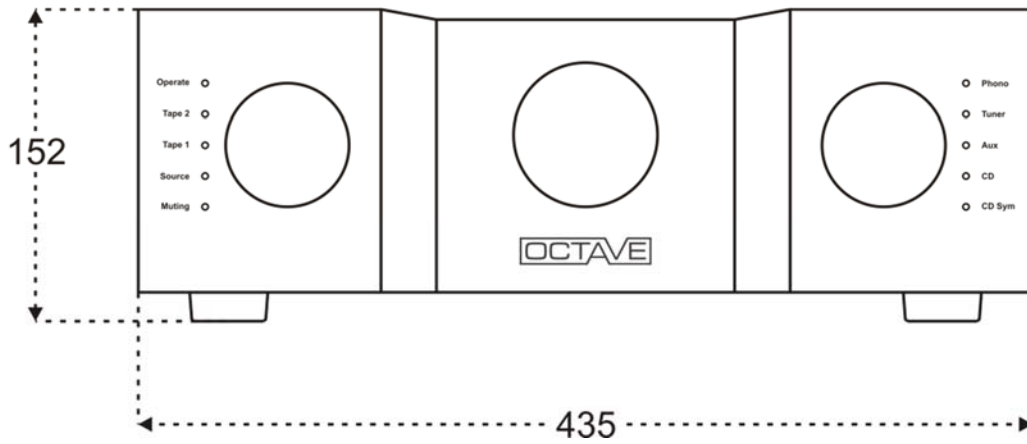

10. SPECIFICATION

10.3 DIAGRAMS

Frequency response

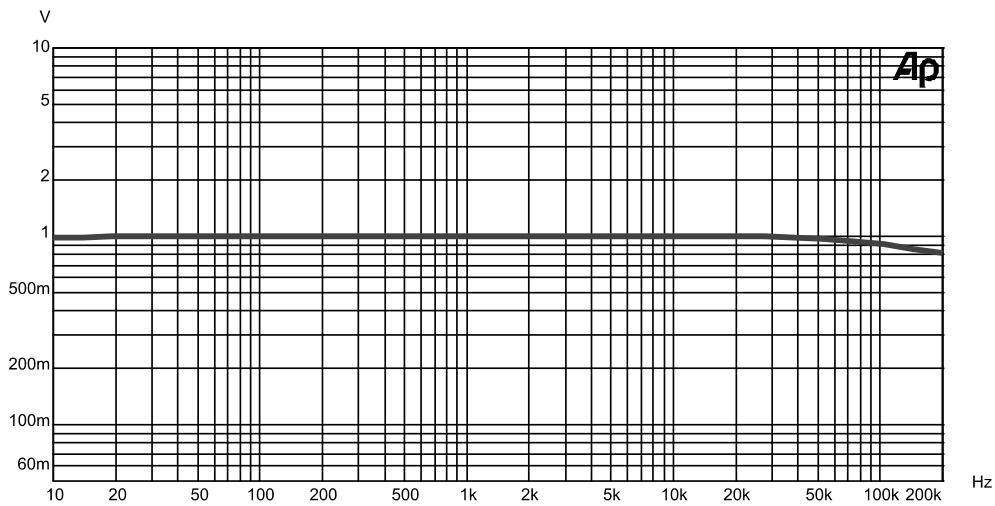

Extremely linear frequency response. No fall in level at lowest bass frequencies.

Distortion spectrum

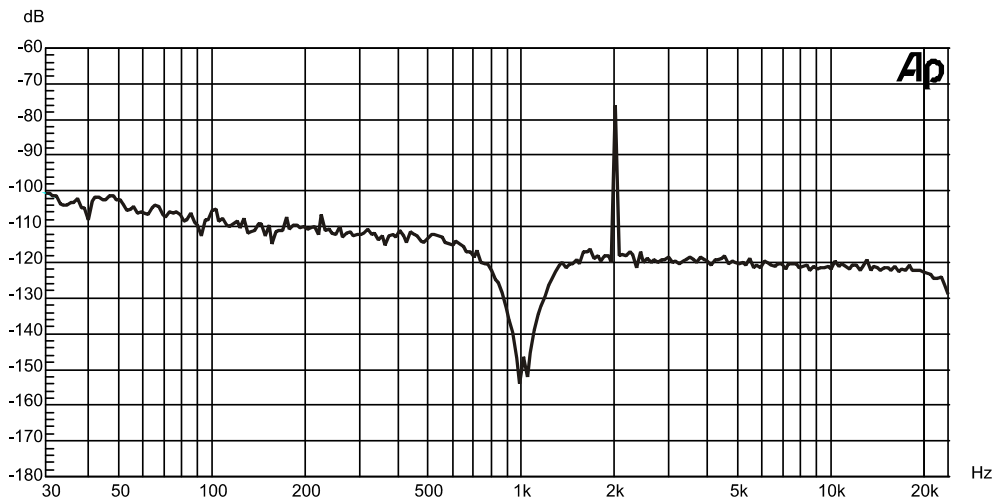

Distortion spectrum at 1 kHz: only second harmonic k2 is discernible; no residual hum at 50/100Hz.



We reserve the right to alter and improve the specifications in pursuit of better. OCTAVE logo is a registered trade mark of Andreas Hofmann. Copyright by Andreas Hofmann

OCTAVEAUDIO T. +49 (0) 7248 3278
ANDREAS HOFMANN F. +49 (0) 7248 3279
REUTAECCKERSTR. 5 INFO@OCTAVE.DE
DE-76307 KARLSBAD WWW.OCTAVE.DE